

VARIANT Compact

Bandsystem mit Aufnahmeelement
im Türflügel

Hinge System with Receiver in the Door
Side

Einbausituationen weiterer Zargentypen
Installation situations of further frame types

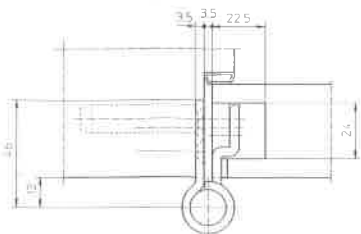

VN 2927/160 Compact

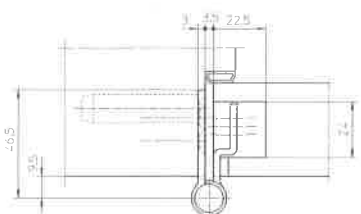

VN 2927/160 Compact Planum

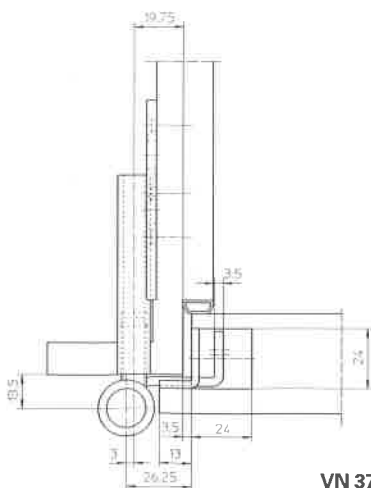

VN 3737/160 Compact

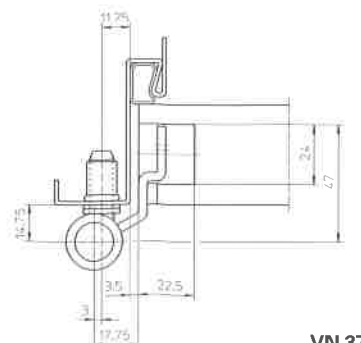

VN 3747/160 Compact

Die stufenlose 3D-Verstellung (Innensechskantschlüssel 4 mm)
Continuous 3D adjustment (4 mm Allen key)

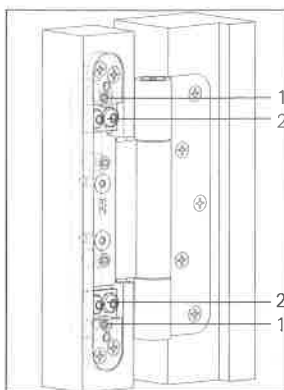

Höhenverstellung:

- Klemmschrauben (2) leicht lösen
- Über die obere Höhenverstellungsschraube (1) die Tür in passende Position bringen (die untere Schraube zurückdrehen)
- Klemmschrauben fest anziehen

Height adjustment

- Slightly loosen the clamping screws (2)
- Adjust the vertical position of the door by turning the upper height adjustment screw (1) (turn the lower height adjustment screw in the opposite direction)
- Retighten the clamping screws

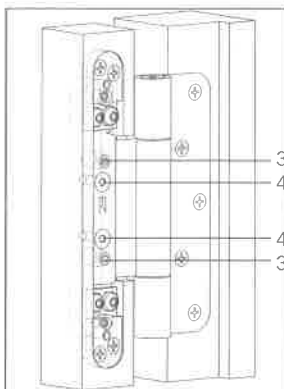

Seitenverstellung

- Klemmschrauben (4) leicht lösen
- Verstellspindel (3) mit Innensechskantschlüssel verstellen
- Drehung rechts - zur Bandseite (max. 3 mm)
- Drehung links - zur Schlosseite (max. 3 mm)

Lateral adjustment

- Slightly loosen the clamping screws (4)
- Adjust the adjusting spindles (3) using a 4 mm Allen key
- Twist right - towards hinge (max. 3 mm)
- Twist left - towards lock (max. 3 mm)

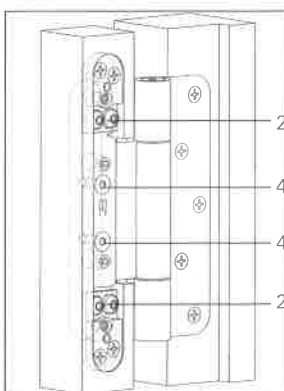

Andruckverstellung

- Klemmschrauben (2 und 4) pro Aufnahmeelement leicht lösen
- Tür in passenden Andruck bringen
- Klemmschrauben wieder festziehen

Compression adjustment

- Slightly loosen the clamping screws (2 and 4) of each receiver
- Put the door to the correct compression
- Retighten the clamping screws